

MULTICHANNEL SINGLE-SHOT TRANSIENT SIGNAL MEASUREMENTS WITH AN OPTICAL FIBER RECIRCULATING DELAY LINE LOOP*

Yan Yin, Anshi Chen, Wangsheng Zhang, Guansan Chen, Xiangzhong Wang, YY Labs, Inc., USA

Abstract

An instrument has been developed to measure single-shot electrical transient signals, in two channels, with frequency responses up to 20 GHz [1]. The instrument utilizes an optical fiber recirculating delay line loop to regenerate captured single-shot signals, and then recovers the original single-shot signals with a sampling scope. The instrument is named Single-Shot Scope.

INTRODUCTION

A real-time oscilloscope, which is useful to study beam instability of Linacs or storage rings, available commercially has frequency responses up to 6 GHz. For frequencies above 6 GHz, the only available instrument is the streak camera, which measures optical signals. Users need to convert the optical signals into electrical signals in order to perform measurements. The streak camera turns the optical signals into low-energy photoelectrons, and then uses a fast sweeping electrical field to deflect the photoelectron beam. The longitudinal intensity distribution of the beam is represented as a transverse trace displayed by a CCD camera.

YY Labs' Single-Shot Scope is based on a different principle, using fiber recirculating delay-line loop technology, which has been widely used for studying long-haul signal transmission in optical fibers [2]. The Scope captures the single-shot signals in one or two channels, and then regenerates the signals with the aid of a recirculating optical fiber delay line loop. A small portion of the signals, recirculating in the loop up to several thousand turns, is tapped out at each turn, thus forming a copy of the original signal. The energy loss is

compensated for with an optical amplifier. The original amplitudes of the signals are thus recovered. A sampling scope is utilized to obtain the original signal from the pulse train.

The instrument is assembled in two boxes. One box is labeled "Transient Signal Capture," since in it the single-shot transient signal is acquired. The other box is labeled "Pulse Train Generator," since it regenerates the two-channel single-shot signals, forming two pulse trains. The Transient Signal Capture box is located close to the source of the signal; the Pulse Train Generator box is located in the control room. The linking distance between the two boxes is limited by the signal transmission limitation of the RS232 cable.



Figure 1: YY Labs' Single-Shot Scope.

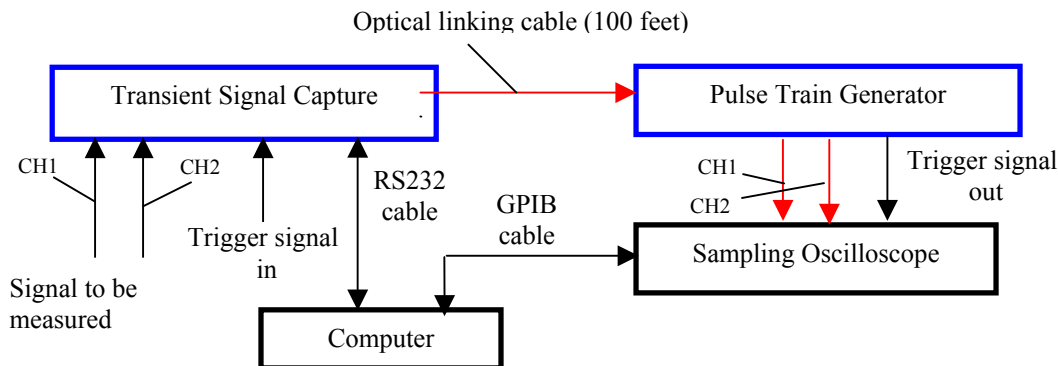

Figure 2: Single-Shot Scope Arrangement. CH, channel.

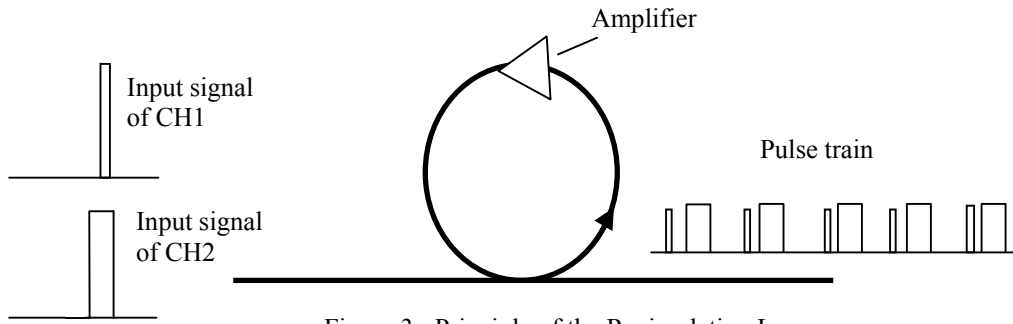

Figure 3: Principle of the Recirculating Loop.

The instrument has a gating function, which allows the instrument to select one signal from a series of signals, or gate the single-shot signal for performing measurements. The gate width is adjustable from 10 ns to 50 ns.

For the purpose of capturing the signal, the instrument has an auto-scan function. If the approximate delay time between the trigger signal and the signal to be measured is known, the delay time can be set via the computer. If the delay time of the signal is unknown, an approximation should be made, and the auto-scan function will locate and capture the signal. The scan range is 500 ns.

The instrument can measure two single-shot signals simultaneously. The two single-shot signals will be captured and injected into the fiber loop for circulation, and will form two separate pulse trains.

The number of circulations of the signal in the delay line loop is set at 1000. Each circulation takes 8 μ s. Figure 4 shows the signal circulation of 1000 turns, which is 8 ms.

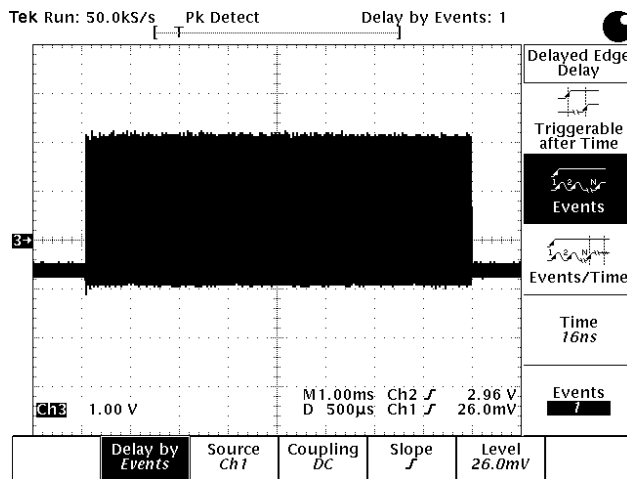

Figure 4: Circulation of 1000 Turns.

Figure 5 shows part of the circulation for a pair of pulses representing two different single-shot signals.

The advantages of using this method reside in the high-frequency response and the low loss of optical fiber, because, in this frequency range, the electrical method cannot be used due to problems of loss, dispersion, and reflection. Regarding the optical fiber, with a core diameter of only 9 μ m and attenuation of 0.2dB/km, the frequency response can easily go up to the 20-GHz range.

With the recirculating-loop method, a high-frequency instrument can be constructed with optical fiber components and low-frequency electronics. In this manner, therefore, a low-cost multichannel, high-frequency single-shot transient signal scope can be built. This PC-based, button-free instrument is easy to use.

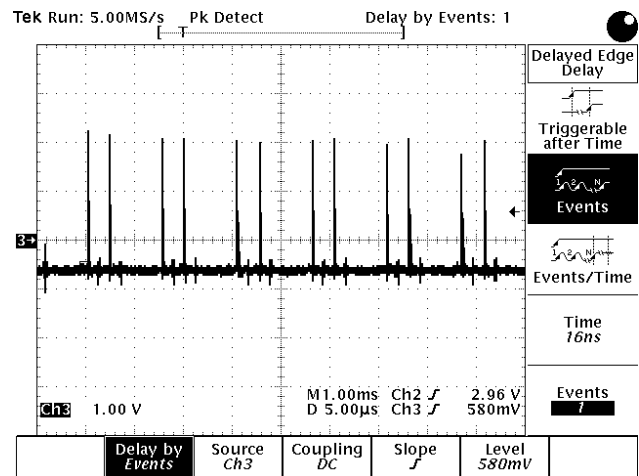

Figure 5: Circulations of Two Signals.

For the tests performed, 10-GHz photodiodes were used, which limited the frequency response to 10 GHz.

Beam tests were carried out at SLAC, as described here.

BEAM TESTS AT SLAC

The PEP-II is an $e^+ e^-$ collider with asymmetric energies in a 2200-m tunnel at the Stanford Linear Accelerator Center [3]. The PEP-II facility consists of two independent storage rings, one on top of the other, in the PEP tunnel. The high-energy ring stores a 9-GeV electron beam, and the low-energy ring stores 3.1-GeV positron beam.

The signal was taken from a button-type capacitive pick-up of 15-mm diameter, in the straight section of Region 4, 350 m from the interaction point, where the BaBar detector is located. The PEP-II was operated in multibunch mode, with e^+ and e^- circulating in the rings. The rms bunch lengths, σ , of the e^+ and e^- beams are in the range of 11 to 12 mm, which is equivalent to 40 ps, and with a FWHM of 90 ps. Without access to the tunnel,

it was not possible to place the signal capture box near the beamline, and so the signal was brought to the measurement room through an existing 35-m Heliac cable (LDF2-50), nevertheless still attenuates the high frequency, the signal was somewhat stretched. For this reason, the pulse length measured was about 174 ps, with a rise time of 164 ps, and fall time of 140 ps (from peak to baseline).

Figure 6 shows the e+ beam signal measured by the Single-Shot Scope. Since the Single-Shot Scope gating-signal generator has a DC offset, the baseline of the signal is not at 0 volts

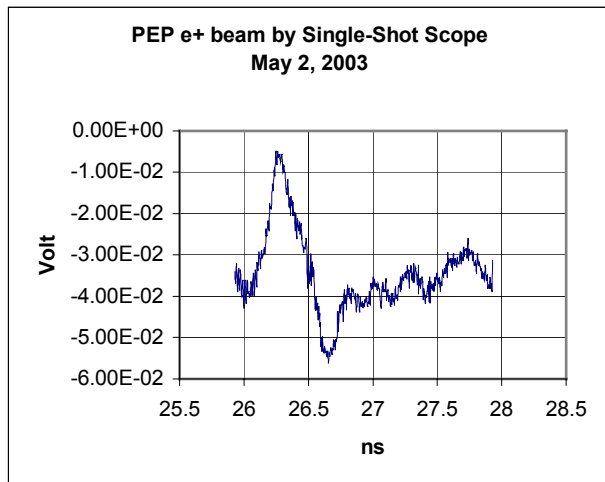

Figure 6: PEP-II e+ Beam Bunch Longitudinal Distribution Measured With the Single-Shot Scope

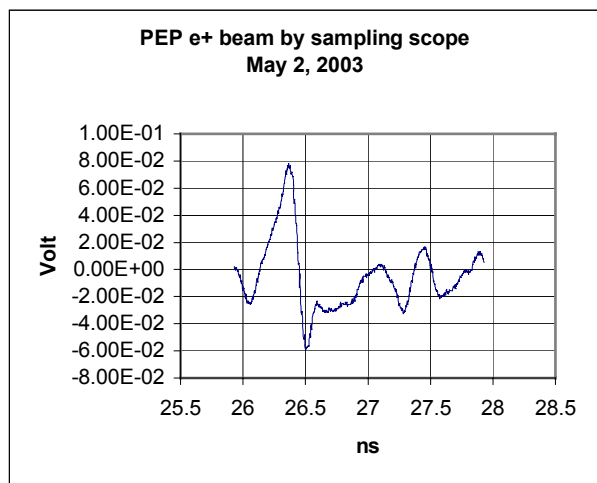

Figure 7: PEP-II e+ Beam Bunch Average Longitudinal Distribution Measured Directly With the TEK 11801 Sampling Scope

Figure 7 shows the e+ beam signal measured by the TEK11801 sampling scope with a trigger pulse produced by the RF signal, once for each turn of the beam. Although Figure 6 and 7 are similar, but there is some discrepancy, which is being studied.

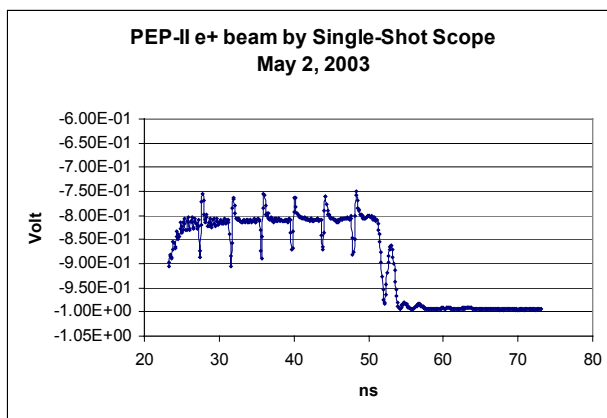

Figure 8: e+ Bunches Captured by the Single-Shot Scope show that multiple bunches can be measured

Figure 9 is an actual picture taken at the time of the measurement. The signal shown is negative, because the slope of the modulator, which converts the electrical signal to an optical signal, was set to negative.



Figure 9: PEP-II e+ Beam Measured by the Single-Shot Scope

ACKNOWLEDGEMENT

The authors thank SLAC and SSRL for their most valuable support of this work, by providing testing opportunities, space, and equipment for the experiments, and acknowledge various helpful discussions with James Sebek, Bob Hettel, Alan Fisher, and Herman Winick.

REFERENCES

- [1] <http://www.YYLabs.com>
- [2] Emmanuel Desurvire "Erbium Doped Fiber Amplifiers: Principles and Applications," John Wiley & Sons, Inc., 1994, p499
- [3] J.T. Seeman, *et al.*, "Status and Future Plans of the PEP-II B-Factory," SLAC-pub-9451, August 2002.